



THE EASY TO FIT DIY MOTORISED ROOF ROLLER BLIND

The SkyFit™ Motorised roof roller blind is a fantastic solution for small, flat or sloping roof windows up to 160cmx300cm. With a winding tube in the head box and the motor in the foot box tension is applied to the fabric to prevent sagging. Can be battery operated (up to 200cm length) or mains powered (up to 300cm length).

The blind is designed to be fitted inside the recess and is available in both blackout and anti-glare fabrics. It is capable of blocking out light and draughts thanks to the exceptional quality of its individual components.

Each part of the blind from the motor to the brush seals and aluminium frames are designed to last. The SkyFit™ Motorised roof roller blind comes with a full 5 year guarantee.



Technical Details

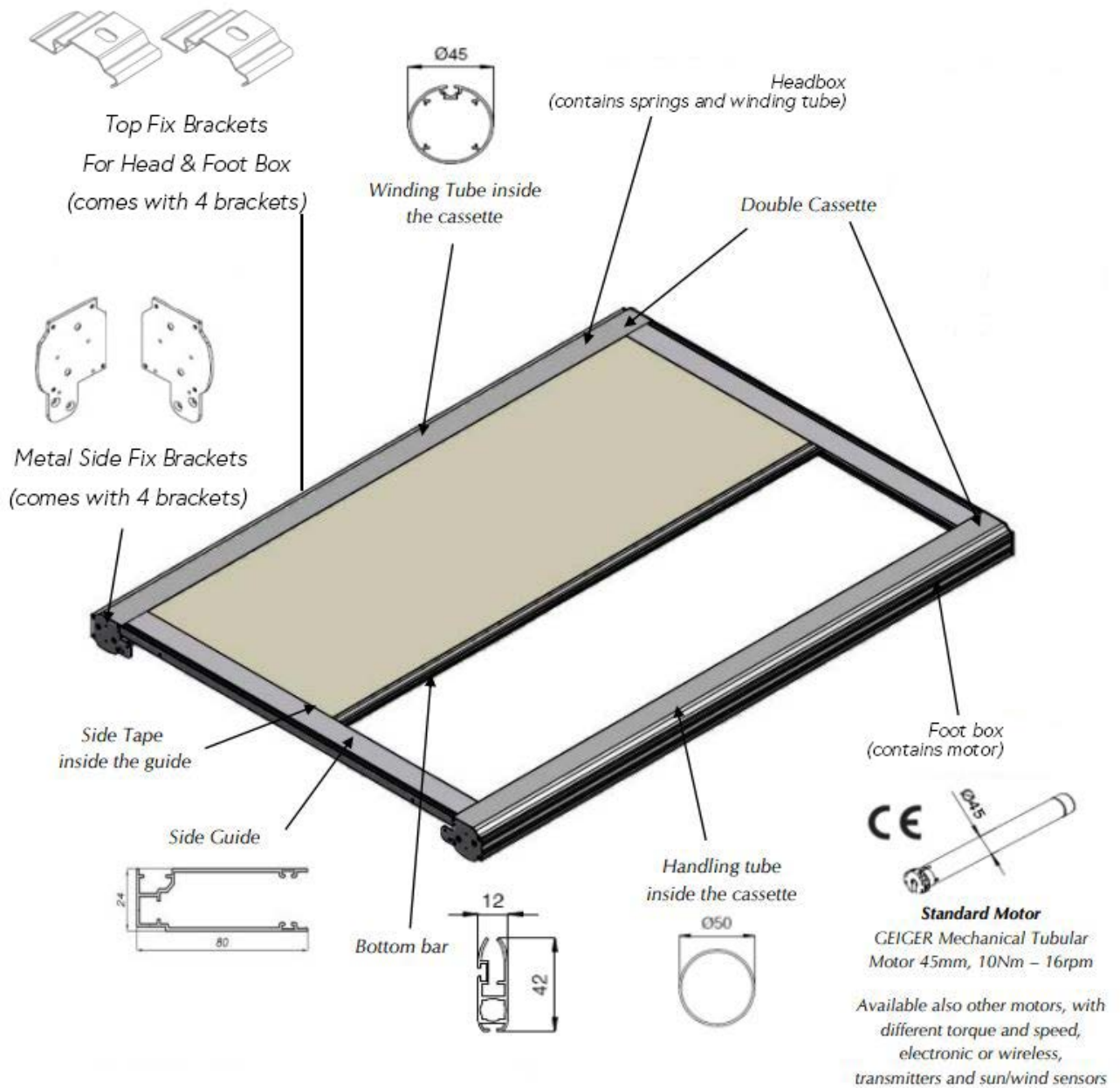

Product Dimensions

Head & Foot Box Dimensions

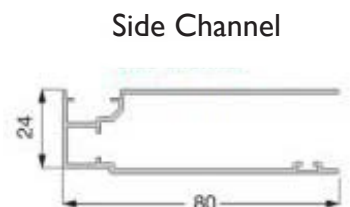
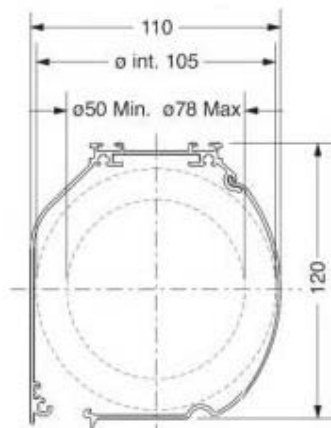
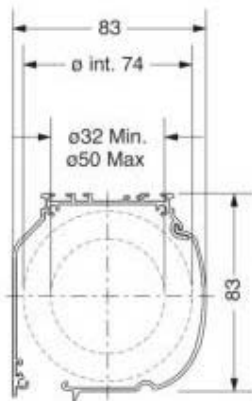
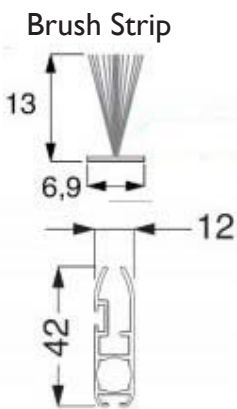

Motor Options

The SkyFit™ Motorised Roof Roller blind is available with a choice of motors.

Option 1:
Somfy® Sonesse 28 Wirefree RTS
Battery Operated Motor
up to 200cm length



- RTS Technology (Radio Technology)
 - Battery operated motor - no electrician needed
 - Built-in rechargeable lithium-ion battery
- Somfy® Remote control or Battery operated SMOOVE wall switch
 - Comes with a charger (needs topping up every 3-6 months)
 - Smooth motion with adjustable speed control
 - Compatible with Situo® Variation for precise tilt control

Option 2:
Somfy® Altus 50 RTS
Mains Powered Motor
up to 300cm length



- RTS Technology (Radio Technology)
 - Mains powered (needs a switched fused spur fitting by an electrician)
 - Motor comes with 3-core cable (length 2.5m)
 - Amazon Alexa or Google Home (requires a Hub at additional cost)
 - Somfy® Remote control or Battery operated SMOOVE wall switch
 - 240v motor

Option 3:
Somfy® LT50 Mains Powered Motor
for use with wall switch only
up to 300cm length



- WT Technology (WiredTechnology)
 - Mains powered (needs a switched fused spur fitting by an electrician)
 - Comes with a white 4-core cable (length 3m)
 - Somfy® Wall Switch Operated (latching rocker switch)
 - 240v motor

SkyFit[™] Motorised Blind Features

SkyFit[™] motorised blinds incorporate a number of specially developed features that enhance the premium quality of our blinds.



Aluminium Frame Colours

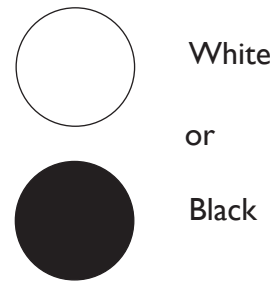

Fixing Brackets

Four brackets are supplied, 2 for the head box and 2 for the foot box

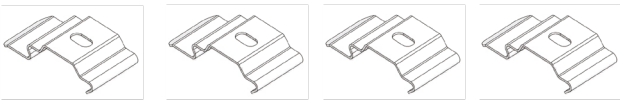

Integral Side Fix Brackets

Four brackets are supplied, one for each corner of the blind.

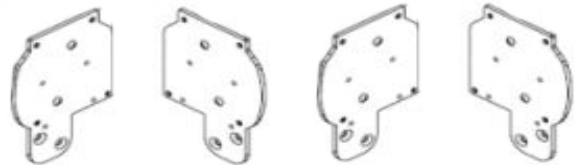

Wire Free

The SkyFit[™] Motorised blind is a tensioned roller blind system with a head and foot cassette and side channels.

The blind is operated by a pulley system and the fabric is pulled down through the siderails. It is operated by either a remote control or wall switch.

Seals

Brushes are inside the side channels and attached to the bottom bar. When the blind is closed, they create a barrier between the blind and the recess blocking out light, reducing heat loss and draughts.



Fabric Colour Options

Blackout

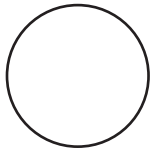

White

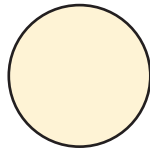

Cream

Anti Glare

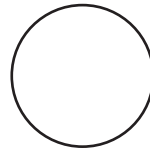

White

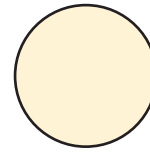

Cream

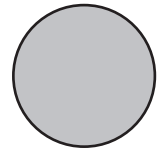

Pale Grey

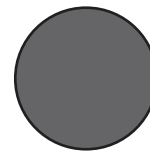

Rock Grey

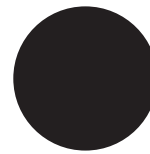

Black

Examples of Suitable Windows

For both horizontal and sloping roof windows the SkyFit™ blind sits inside the window recess. Examples of suitable windows are displayed below.



How to Measure

To ensure a tight fit we require you to measure the recess width in three places and recess length in three places as illustrated in the image opposite.

We will deduct 2mm off the width and 2mm off the length during manufacture.

Size Restrictions

Battery Operated Motor:

Minimum Size: 750mm Width x 500mm Length

Maximum Size: 1600mm Width x 2000mm Length

Mains Powered Motor

Minimum Size: 800mm Width x 500mm Length

Maximum Size: 1600mm Width x 3000mm Length

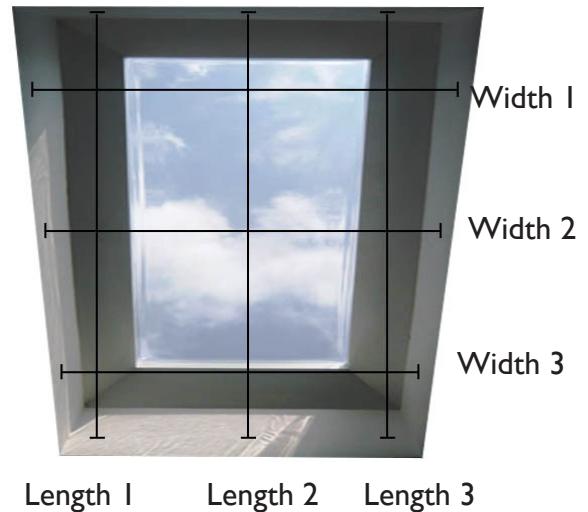

Measurements required in mm

Maintenance & Care

The two part head box, foot box and side channel hardware is manufactured from extruded aluminium. This comes as standard in a white powder coated aluminium or black powder coated aluminium.

If there is a failure of the blind, components can be replaced without the need for a new complete blind.

To keep the blind looking it's best you must ensure the blind has been installed correctly. The fabric can be cleaned with a synthetic or feather duster and can be wiped lightly with a damp cloth.

Operation

RTS (Radio Technology Somfy®) Options

- Somfy® Single channel remote for operating a single blind
- Somfy® Multi channel remote for operating multiple blinds
- Somfy® SMOOVE Battery operated wall switch
- Somfy® TaHoma SWITCH smart home automation (to make compatible with Alexa and Google Home)

WT (Wired Technology) Option

- Somfy® Smoove DUO WT Hard Wired latching rocker switch

SkyFit™ Motorised Order Form

Date:

Invoice Address:

Name:

Address:

Postcode:

Phone:

Email:

Delivery Address:

Name:

Address:

Postcode:

Phone:

Email:

1. Measurements

Recess Size: We require the recess size; the tight wall to wall measurement in mm, no deductions made by you the customer. We will use the smallest width and the smallest length and then deduct 2mm off each of these sizes.

Blind 1	Blind 2	Blind 3
Width 1:	Width 1:	Width 1:
Width 2:	Width 2:	Width 2:
Width 3:	Width 3:	Width 3:
Length 1:	Length 1:	Length 1:
Length 2:	Length 2:	Length 2:
Length 3:	Length 3:	Length 3:

Blinds up to and including 2000mm long will come with an 83mm depth head and foot box.
Blinds over 2000mm long will come with a 110mm depth head and foot box.
Side channels remain the same size.

2. Fabric Choice

Tick where appropriate

Blind 1:

Blackout White

Blackout Cream

Anti Glare White

Anti Glare Cream

Anti Glare Grey

Anti Glare Rock

Anti Glare Black

Blind 2:

Blackout White

Blackout Cream

Anti Glare White

Anti Glare Cream

Anti Glare Grey

Anti Glare Rock

Anti Glare Black

Blind 3:

Blackout White

Blackout Cream

Anti Glare White

Anti Glare Cream

Anti Glare Grey

Anti Glare Rock

Anti Glare Black

3. Frame Colour

Blind 1: White Black	Blind 2: White Black	Blind 3: White Black
--	--	--

4. Motor Options

Tick where appropriate

Blind 1 Blind 2 Blind 3

OPTION 1: Somfy® Sonesse 28 Wirefree RTS Battery Powered Motor

- Standard motor, works with Somfy® Remote control or Battery operated SMOOVE wall switch.
- Connection to Amazon Alexa or Google Home (requires a Somfy® TaHoma hub at additional cost)
- NO Electrician required
- Maximum size 1600mm x 2000mm
- Built-in rechargeable lithium-ion battery
- Comes with a charger (needs topping up every 3-6 months)
- Smooth motion with adjustable speed control
- Compatible with Situo® Variation for precise tilt control
- RTS Technology (Radio Technology)



OPTION 2: Somfy® Altus 50 RTS Mains Powered Motor

- Standard motor, works with Somfy® Remote control or Battery operated SMOOVE wall switch.
- Connection to Amazon Alexa or Google Home (requires a Somfy® TaHoma hub at additional cost)
- Maximum Size: 1600mm x 3000mm
- Mains powered, electrician required to install a switched fused spur.
- Motor comes with a 3-core cable (length 2.5m)
- 240v motor



OPTION 3: Somfy® LT50 WT Mains Powered Motor

- Wired Technology only operated with Somfy® Latching rocker wall switch.
- Maximum Size: 1600mm x 3000mm
- Mains powered, electrician required to install a switched fused spur.
- Comes with a white 4-core cable (length 3m)
- 240v motor



5. Cable Exit

Tick where appropriate

For battery operated blinds leave blank and move on to step 6.

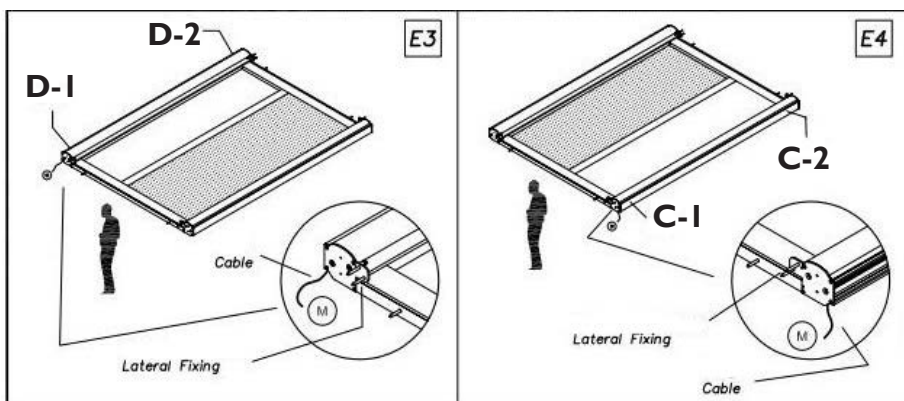

D1 D2 C1 C2

Blind 1

Blind 2

Blind 3

PLEASE NOTE: THE SKYFIT MOTORISED BLIND HAS THE **MOTOR IN THE FOOT OF THE BLIND** (THE OPPOSITE END TO WHERE THE FABRIC COMES OUT OF)

If your blind is mains powered please indicate where you would like the cable to exit D1, D2, C1 or C2.

6. Control Options

Tick where appropriate

RTS (Radio Technology Somfy®) Options

Blind 1

Blind 2

Blind 3

Somfy® Single channel remote for operating a single blind.



Somfy® Multi channel remote for operating multiple blinds.



Somfy® SMOOVE Battery operated wall switch



Somfy® TaHoma Switch (add £179) To make operation compatible with Alexa® and Google Assistant



WT (Wired Technology) Option

Somfy® SMOOVE DUO WT Hard Wired Latching Rocker Switch



Customer Signature:

Agreed Amount:

Date:

I confirm that I have read and agreed to the attached terms and conditions

Customer Signature:

These terms & conditions apply to any of the products listed on skylight-blinds-direct.co.uk. Please read them before you buy from us. By ordering products from us you agree to be bound by these terms & conditions.

You should print a copy of these terms & conditions for future reference.

1. WHO ARE WE?

www.skylight-blinds-direct is a trading name for Meadow Blinds Ltd
Our **registered office** is Onward Chambers, 34 Market street, Hyde, SK14 1AH.
Our **company number** is 08130391. Our **VAT number** is 153440728.

2. YOUR STATUS

By placing an order through our site, you warrant that:

- (a) You are legally capable of entering into binding contracts; and
- (b) You are at least 18 years old; and

In these conditions:

- 2.1 "Contract" means the contract, comprising these conditions, for supply of Product;
- 2.2 "Customer" means any customer who is purchasing outside the course of his or her business or trade;
- 2.3 "Order" means your payment for one of our products as illustrated on our website.
- 2.4 "Order Confirmation" means our email to you confirming the Order;
- 2.5 "you" / "your" mean the Customer submitting an order for Product;
- 2.6 "we"/"us"/"our" means Meadow blinds trading as Skylightblinds Direct (as per 1. On these terms and conditions)
- 2.7 "Website" means www.skylight-blinds-direct.co.uk.

3. DESCRIPTION OF OUR PRODUCTS

Standard products

- Any **manual** blind on our website that you can buy directly online through the standard ordering process (these blinds tend to be on the shelf products).

Non-standard products

- Any **motorised** skylight blind that can be ordered online through the standard ordering process (these blinds are made to order).

Flat roof blinds

- Any LanternLITE™ product or made to measure product that suits a flat roof of tilted roof window.
- These blinds are ordered with much liaison through the office and not paid for directly through the standard website checkout process.

4. HOW THE CONTRACT IS FORMED BETWEEN YOU AND US

The Main steps of placing an order are set below.

4.1 Standard and non standard products from the website

- You choose your product from our website
- Add to your basket
- Checkout & pay by card or Paypal
- You will receive your blind within a set period of time
Standard products: 3-10 working days depending on size
Non standard products: 10-14 working days

4.2 Flat roof blinds

- You contact us for a quote
- We email you over a quote
- You confirm verbally or via email that you would like to proceed with the quote
- We send you over an order form where you fill out your measurements
- We send you a pro forma invoice
- You pay the invoice (by card or into our bank account)
- We provide you with the goods within an agreed upon time. Zip blinds lead time is usually 10 working days. Honeycomb blinds lead time is usually 3-4 weeks. These are subject to change.

5. SIGNING THE TERMS & CONDITIONS (FOR FLAT ROOF BLINDS)

If and when you want to place an order with us you will have to confirm acceptance of these terms & conditions by ticking a box and signing your name and dating it (flat roof blinds only). Such confirmation implies full acceptance of our terms and conditions of supply.

Once the terms & conditions have been signed, your order form has been acknowledged by the office and you have paid for your goods in full, we will get your order into production.

6. Order Acknowledgment

After placing an order, you will receive an e-mail from us acknowledging that we've received your order and payment (the Order Acknowledgment of Receipt). Please note that this does not mean that your order has been accepted. Your order constitutes an offer to us to buy a Product. All orders are subject to acceptance by us. We will inform you in writing if for any reason your order has not been accepted by us.

7. CONSUMER RIGHTS

7.1 Standard products

To cancel a Contract, you must inform us in writing.

- If the product has been dispatched already you will have to return the product via recorded delivery at your own cost
- Once the blind has been signed back into the factory and is in a saleable condition (proof required hence recorded delivery) we will give you a full refund less the original delivery charge if there was one.

7.2 Non-Standard products

To cancel a Contract, you must inform us in writing.

- If the product has been started in manufacture you can cancel less a 10% handling fee
- If the product has been dispatched already you will have to return the product via recorded delivery at your own cost
- Once the blind has been signed back into the factory and is in a saleable condition (proof required hence recorded delivery) we will give you a refund less 30% handling fee and the original delivery charge if there was one.

7.3 Flat roof blinds

If the order has already been started by the factory you will not have any right to cancel the order.

8. RISK AND TITLE

8.1 The Products will be at your risk from the time of delivery.

8.2 Ownership of the Products will pass to you only once the Products have been delivered and we have received full payment of all sums due in respect of the Products, including delivery charges.

9. PRICE AND PAYMENT

9.1 The prices indicated on the site include VAT but exclude delivery costs, possible refunds or any other applicable taxes, which will be added to or deducted from the total amount due as set out in the summary of your order indicated prior to payment processing.

9.2 Prices are liable to change at any time, but changes will not affect orders we have expressly accepted in an Order Acceptance/invoice.

9.3 Our site contains a large number of products and it is always possible that, despite our best efforts, some of the blinds listed on our site may be incorrectly priced.

9.4 We are under no obligation to provide the product to you at the incorrect (lower) price, even after we have sent you a Dispatch Confirmation.

9.5 Payment for all Products must be by credit card, debit card, bank transfer or paypal transaction.

9.6 All products available on our site are pro forma and will not be manufactured until the customer has paid in full

10. FREE SAMPLES

Free samples are available to order on our website, over the phone or by email. If you choose a colour of blind based on images on the computer and you do not like the colour when you receive it we will not be able to refund your order.

11. DELIVERY

11.1 Any delivery time given by us is a best guess and we will not be liable to you for any loss or damage sustained by you if we fail to meet that time scale because of circumstances beyond our reasonable control. We outsource our delivery to UK couriers. Some UK postcode areas may be subject to a longer delivery time.

Any delivery date indicated on the website, including in the Order Acceptance, are merely estimates and are not binding on us.

11.2 You must notify us of any faulty, damaged or missing products within 7 working days from receipt of the delivery of your order.

12. MIS-MEASURES

12.1 Full measuring instructions are available on our website. As flat roof blinds are manufactured according to the measurements you provide, it is very important that your measurements are accurate. We cannot accept the return of the roof lantern blind if the measurements provided to us are incorrect. You are advised to read the roof lantern blinds measurement information pages of our website for guidance on how to take the required measurements accurately. If you measure incorrectly we will try to help the best we can by collecting and using parts from your blind to make a blind the correct size for as cheaply as possible for you (chargeable to the customer).

12.2 If we make a blind at the incorrect size we will collect the blind and remake as per above.

13. FAULTY PRODUCTS

13.1 Standard blinds/Non-standard blinds

Products returned by you because of a defect will be refunded in full. This will include the delivery charge and any return charge (providing we are able to verify that the product is indeed defective). We will examine the returned product and notify you of whether you are entitled to a refund within a reasonable period of time. We will usually process the refund as possible.

Alternatively we will remake the product free of charge (which ever solution is better for you).

13.1 Flat Roof blinds

If these blinds are faulty we have the right to collect and repair the blind. If your product does not function correctly, please refer to the instructions sent with the Product, consult our website, or contact a member of our customer services team on **0800 008 6293**

If after examining the Product we determine that it is defective in components or manufacturing, we will replace it with an identical or equivalent product.

14. PRODUCT RETURNS PROCEEDURE

Please contact our Customer Services department for guidance on our Product returns procedure. Please send all Product securely in the original packaging.

15. REFUNDS

We will usually refund any money received from you using the same credit or debit card reference number used by you to pay for your original purchase.

16. OUR WARRANTY

Standard products: We guarantee all standard products for **3 years** (batteries for one year)

Roof Lantern blinds: We guarantee all Roof lantern blinds for **5 years**.

Scope

During the guarantee period, if your Product does not operate normally because of a defect in components or manufacturing, we will first repair it (in our factory) or send out parts for you to fix it.

If this does not repair the item we will replace it with an equivalent or identical product. The guarantee does not cover the cost of dismantling and refitting the products, nor the replacement of consumables such as batteries. Batteries are guaranteed for 1 year from date of receipt of order

This guarantee does not affect your statutory rights.

Exclusions

The warranty will under no circumstances apply if faults are due to any of the following :

- You fit the product after it is clearly damaged on delivery. If the blind is damaged on delivery please notify the office and we will advise of next steps.
- If your product has been used for any other purpose than that for which we advised they are supplied.
- If installation, use or maintenance instructions have been disregarded and in particular :
 - Connection to an unsuitable power source,
 - Installation on or connection to an unsuitable product,
 - Connection to devices that do not comply with standards
 - Opening of or modification to the product or its components.
- In the event of shock, fire, lightning, flood, gales or any event beyond our control.

17. INSTALLATION

17.1 Please note that in most circumstances we do NOT provide installation services and you are fully responsible for arranging installation of the Products.

17.2 DO NOT ATTEMPT TO FIT ANY OF OUR THEY BLINDS IF APPEAR TO BE DAMAGED. Doing so could be dangerous and is at your own risk.

If the blind looks damaged please immediately email photos, your name and contact details to team@skylight-blinds-direct.co.uk and call 0800 008 6293. Please wait for us to advise how to proceed.

18. PRODUCT LIABILITY

We warrant to you that any product purchased from us through our site is of satisfactory quality and reasonably fit for all the purposes for which we advise that they are supplied, or in the absence of any such purposes having been advised, for all the purposes for which products of the type are commonly supplied.

18.1 Meadow blinds ltd declines all liability for the consequences of installation, use or maintenance of the product which does not comply with the product characteristics, instructions provided by us, uses, or the standards in force : you shall determine the suitability of the product for its intended use, with reference to usual standards, completed by information we provide to you. You are fully liable for the installation of our products.

18.2 We are not responsible for losses which happen as a side effect of the main loss or damage (including but not limited to loss of income or revenue, loss of business, loss of profits or contracts, loss of anticipated savings, loss of data, waste of management or office time) however arising and whether caused by tort (including negligence), breach of contract or otherwise.

18.3 Nothing in this clause or elsewhere in these terms and conditions limits in any way our liability:

18.4 Subject to the exclusions above, our liability for losses you suffer as a result of us breaking this agreement is strictly limited to the purchase price of the Product you purchased.

18.5 Your statutory rights remain unaffected:

PLEASE ALSO NOTE THAT YOU MUST COMPLY WITH ALL APPLICABLE LAWS AND REGULATIONS OF THE COUNTRY FOR WHICH THE PRODUCTS ARE DESTINED. WE WILL NOT BE LIABLE FOR ANY BREACH BY YOU OF ANY SUCH LAWS.

19. WRITTEN COMMUNICATIONS

Applicable laws require that some of the information or communications we send to you should be in writing. When using our site, you accept that communication with us will be mainly electronic.

We will contact you by e-mail or provide you with information by posting notices on our website. For contractual purposes, you agree to this electronic means of communication and you acknowledge that all contracts, notices, information and other communications that we provide to you electronically comply with any legal requirement that such communications be in writing.

This condition does not affect your statutory rights.

20. NOTICES

All notices given by you to us must be given to Meadow blinds ltd, 6 Highmeadow, Outwood, Racliffe, Manchester, M26 1YN at the following email addresses either team@skylight-blinds-direct.co.uk or sales@skylight-blinds-direct.co.uk.

21. TRANSFER OF RIGHTS AND OBLIGATIONS

21.1 The contract between you and us is binding on you and us and on our respective successors and assigns, as from our acceptance of your order by sending the Order Acceptance e-mail.

21.2 You may not transfer, assign, charge or otherwise dispose of a Contract, or any of your rights or obligations arising under it, without our prior written consent.

21.3 We may transfer, assign, charge, sub-contract or otherwise dispose of a Contract, or any of our rights or obligations arising under it, at any time during the term of the Contract.

22. EVENTS OUTSIDE OUR CONTROL

22.1 We will not be liable or responsible for any failure to perform, or delay in performance of, any of our obligations under a Contract that is caused by events outside our reasonable control (Force Majeure Event).

22.2 A Force Majeure Event includes any act, event, non-happening, omission or accident beyond our reasonable control and includes in particular (without limitation) the following:

- (a) Strikes, lock-outs or other industrial action.
- (b) Civil commotion, riot, invasion, terrorist attack or threat of terrorist attack,
- (c) Fire, explosion, storm, flood, earthquake, subsidence, epidemic or other natural disaster.
- (d) Impossibility of the use of railways, shipping, aircraft, motor transport or other means of public or private transport.
- (e) Impossibility of the use of public or private telecommunications networks.
- (f) The acts, decrees, legislation, regulations or restrictions of any government.

22.3 Our performance under any Contract is deemed to be suspended for the period that the Force Majeure Event continues, and we will have an extension of time for performance for the duration of that period. We will use our reasonable endeavours to bring the Force Majeure Event to a close or to find a solution by which our obligations under the Contract may be performed despite the Force Majeure Event.

23. WAIVER

23.1 If we fail, at any time during the term of a Contract, to insist upon strict performance of any of your obligations under the Contract or any of these terms and conditions, or if we fail to exercise any of the rights or remedies to which we are entitled under the Contract, this shall not constitute a waiver of such rights or remedies and shall not relieve you from compliance with such obligations.

23.2 A waiver by us of any default shall not constitute a waiver of any subsequent default.

23.3 No waiver by us of any of these terms and conditions shall be effective unless it is expressly stated to be a waiver and is communicated to you in writing in accordance with clause 14.

24. SEVERABILITY

If any of these terms and Conditions or any provisions of a Contract are determined by any competent authority to be invalid, unlawful or unenforceable to any extent, such term, condition or provision will to that extent be severed from the remaining terms, conditions and provisions which will continue to be valid to the fullest extent permitted by law.

25. OUR RIGHT TO VARY THESE TERMS & CONDITIONS

25.1 These terms & conditions and any document expressly referred to in them represent the entire agreement between us in relation to the subject matter of any Contract and supersede any prior agreement, understanding or arrangement between us, whether oral or in writing.

25.2 We each acknowledge that, in entering into a Contract, neither of us has relied on any representation, undertaking or promise given by the other or be implied from anything said or written in negotiations between us prior to such Contract except as expressly stated in these terms and conditions.

25.3 Neither of us shall have any remedy in respect of any untrue statement made by the other, whether orally or in writing, prior to the date of any Contract (unless such untrue statement was made fraudulently) and the other party's only remedy shall be for breach of contract as provided in these terms and conditions.

26. LAW AND JURISDICTION

26.1 We have the right to revise and amend these terms and conditions from time to time.

26.2 You will be subject to the policies and terms and conditions in force at the time that you order products from us, unless any change to those policies or these terms and conditions is required to be made by law or governmental authority (in which case it will apply to orders previously placed by you), or if we notify you of the change to those policies or these terms and conditions before we send you the Dispatch Confirmation (in which case we have the right to assume that you have

accepted the change to the terms and conditions, unless you notify us to the contrary within seven working days of receipt by you of the Products).

26.3. LAW AND JURISDICTION

This site, any exchange arising there-from and any Contracts for the purchase of Products through our site will be governed by English law. Any dispute arising from, or related to the use of this site or such Contracts shall be subject to the exclusive jurisdiction of the courts of England and Wales.

Our use of your personal data is governed by our “privacy policy” which can be found on our website.